

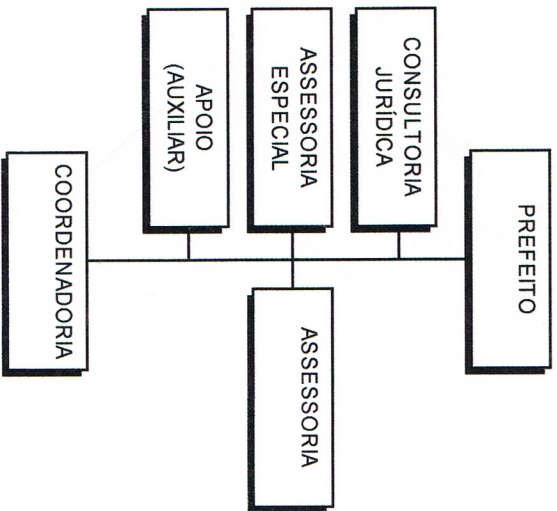

ESTADO DO RIO DE JANEIRO
CÂMARA MUNICIPAL DE BARRA DO PIRAI

GABINETE DO PREFEITO





ESTADO DO RIO DE JANEIRO
CÂMARA MUNICIPAL DE BARRA DO PIRAI
GABINETE DO PRESIDENTE

CONTROLADORIA GERAL

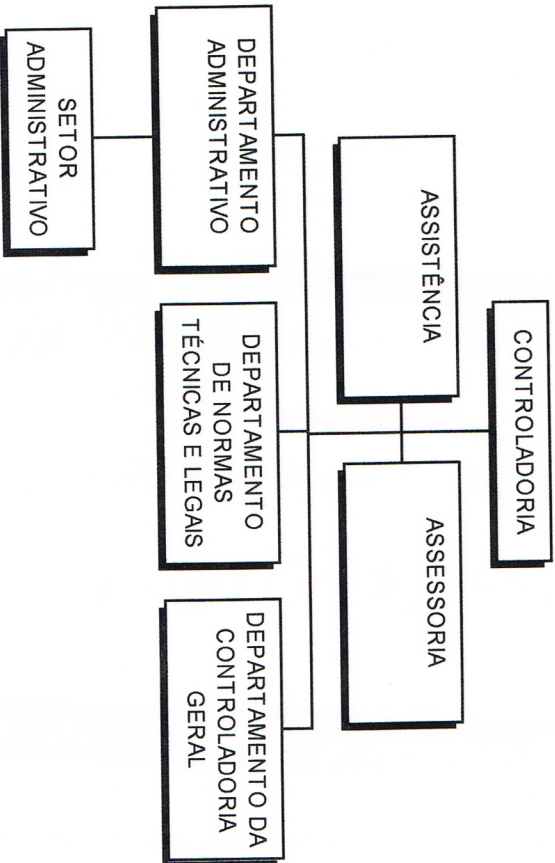



ESTADO DO RIO DE JANEIRO
CÂMARA MUNICIPAL DE BARRA DO PIRAJÍ

PROCURADORIA GERAL DO MUNICÍPIO

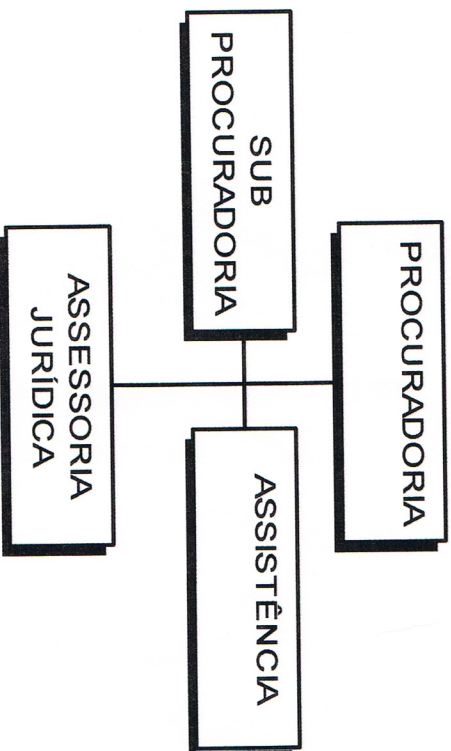

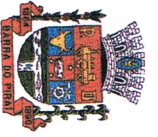

ESTADO DO RIO DE JANEIRO
CÂMARA MUNICIPAL DE BARRA DO PIRAÍ

FUNDO DE PREVIDÊNCIA DO MUNICÍPIO

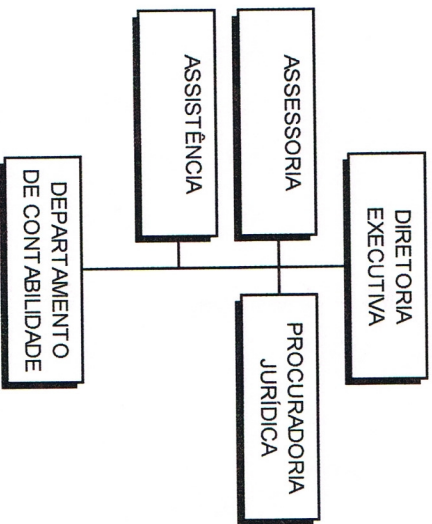

[Handwritten signature]



ESTADO DO RIO DE JANEIRO
CÂMARA MUNICIPAL DE BARRA DO PIRAI

SECRETARIA MUNICIPAL DE ADMINISTRAÇÃO

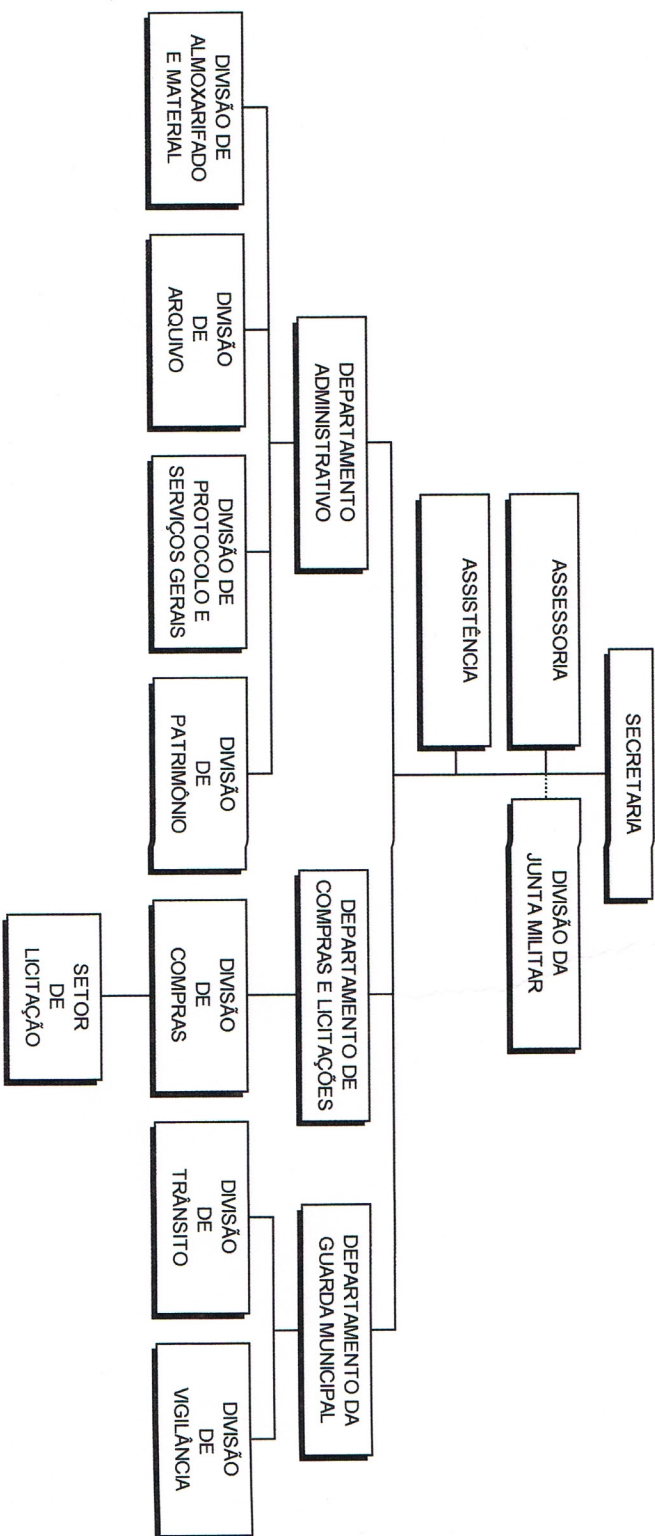

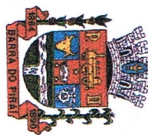

ESTADO DO RIO DE JANEIRO
CÂMARA MUNICIPAL DE BARRA DO PIRAÍ

SECRETARIA MUNICIPAL DE AGRICULTURA E MEIO AMBIENTE

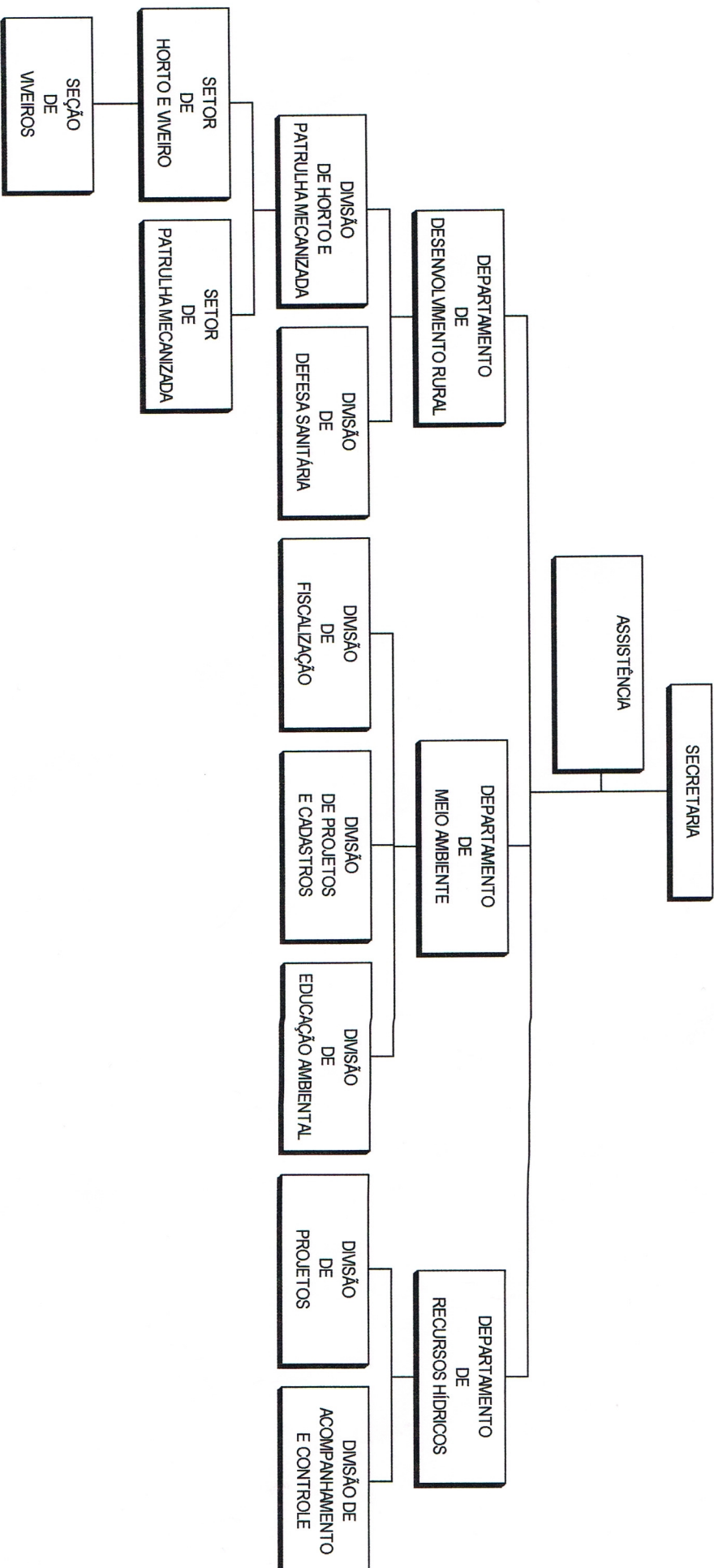

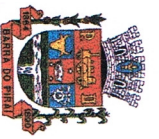

SECRETARIA MUNICIPAL DE ÁGUA E ESGOTO

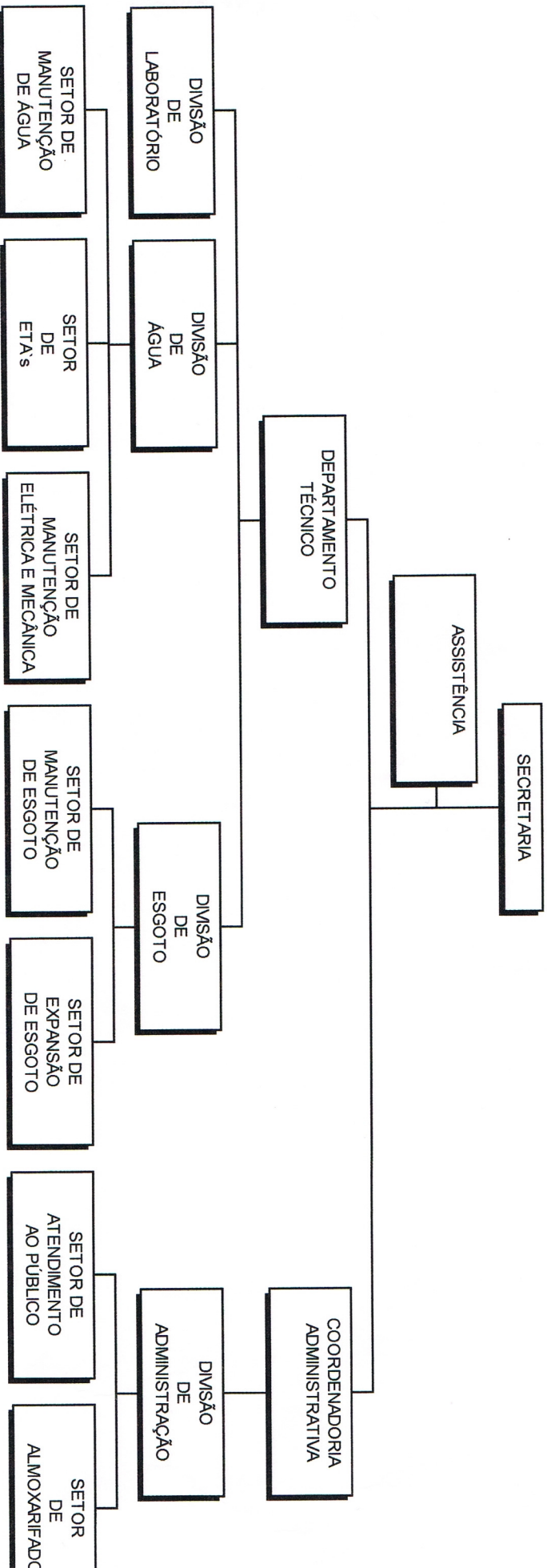

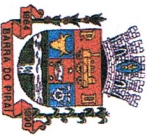

ESTADO DO RIO DE JANEIRO
CÂMARA MUNICIPAL DE BARRA DO PIRAÍ

SECRETARIA MUNICIPAL DE ASSISTÊNCIA SOCIAL

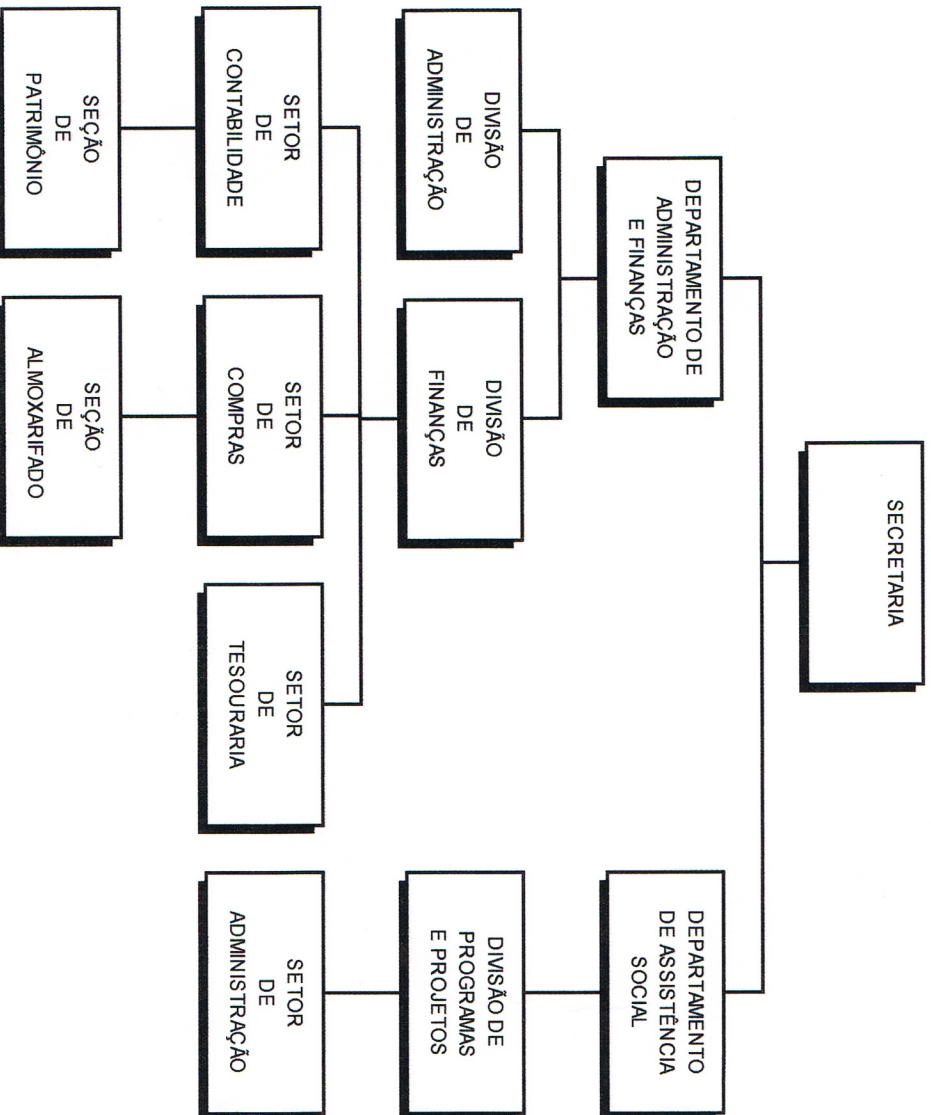



ESTADO DO RIO DE JANEIRO
CÂMARA MUNICIPAL DE BARRA DO PIRAÍ

SECRETARIA MUNICIPAL DE EDUCAÇÃO E DESPORTO

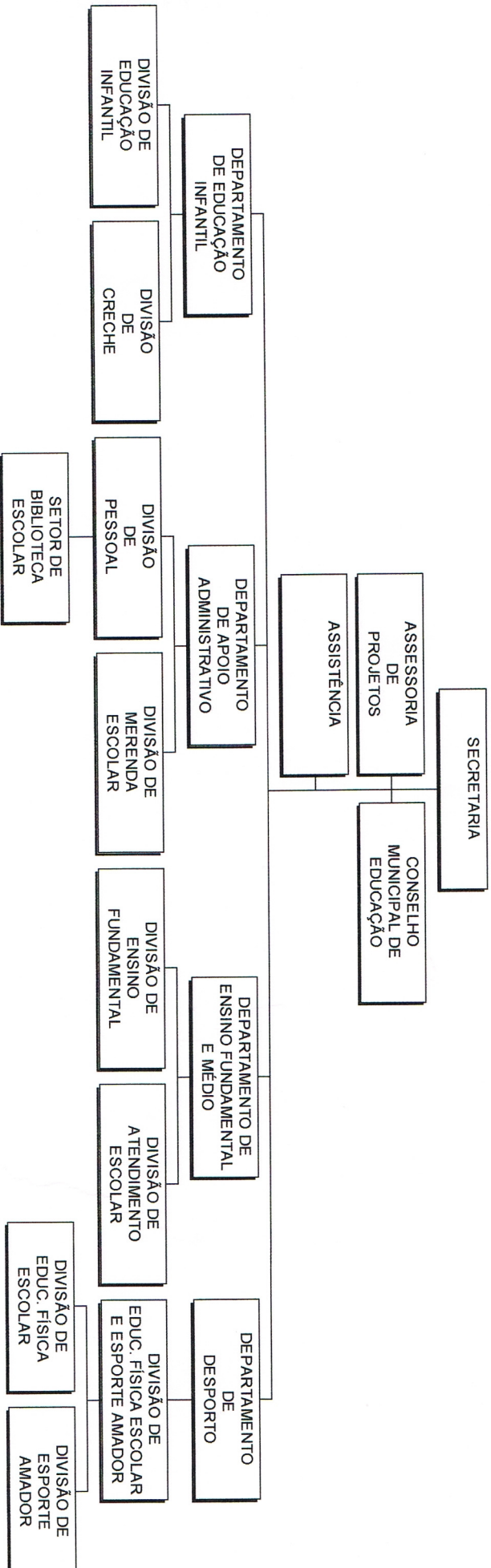

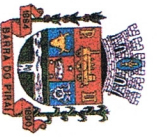

ESTADO DO RIO DE JANEIRO
CÂMARA MUNICIPAL DE BARRA DO PIRAI

SECRETARIA MUNICIPAL DE FAZENDA

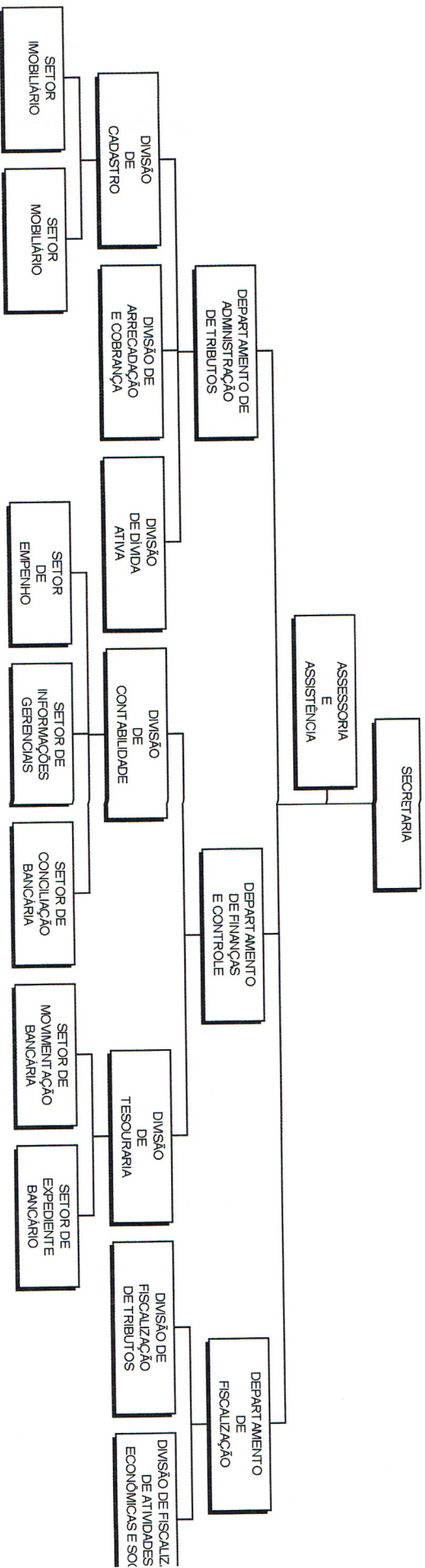



ESTADO DO RIO DE JANEIRO
CÂMARA MUNICIPAL DE BARRA DO PIRAI

SECRETARIA MUNICIPAL DE GOVERNO

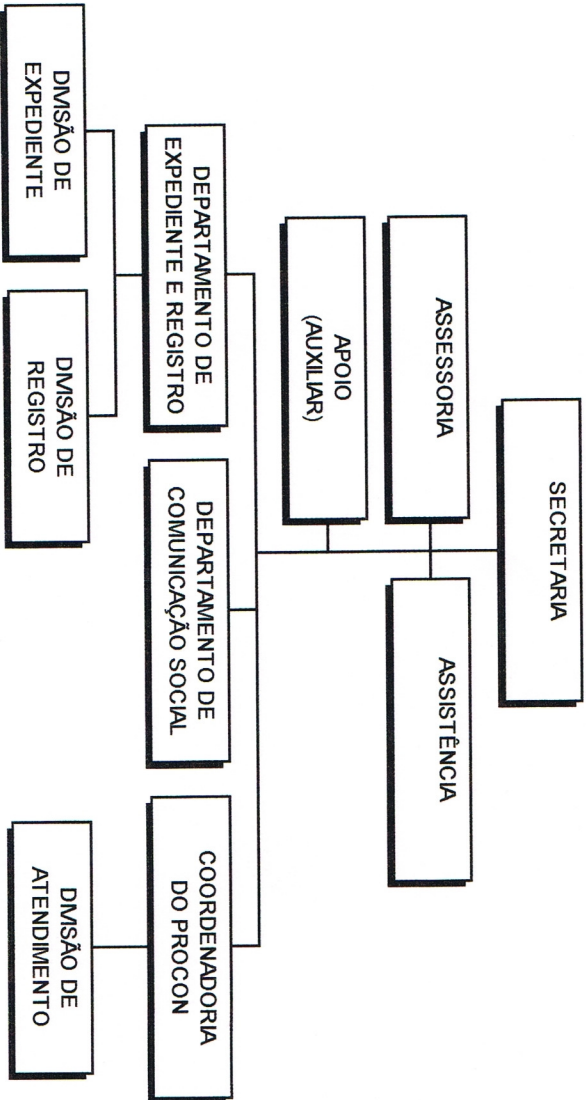



ESTADO DO RIO DE JANEIRO
CÂMARA MUNICIPAL DE BARRA DO PIRAÍ

SECRETARIA MUNICIPAL DE OBRAS

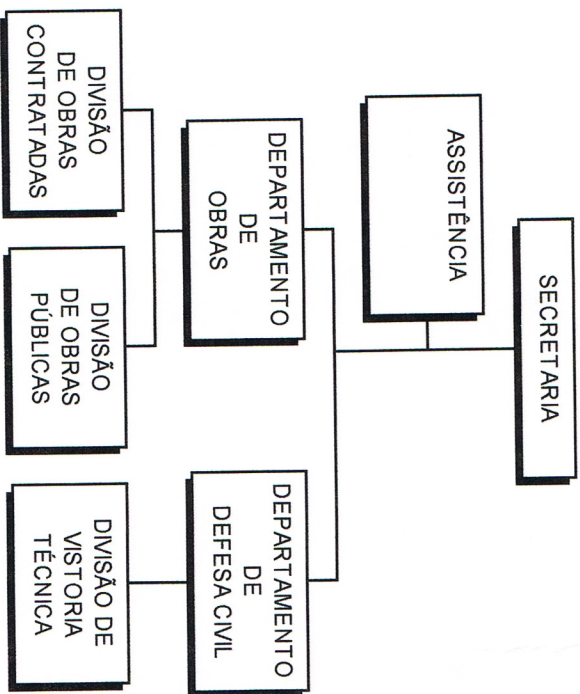

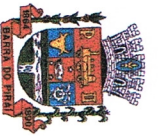

STADO DO RIO DE JANEIRO
CÂMARA MUNICIPAL DE BARRA DO PIRAI

SECRETARIA MUNICIPAL DE PLANEJAMENTO E COORDENAÇÃO

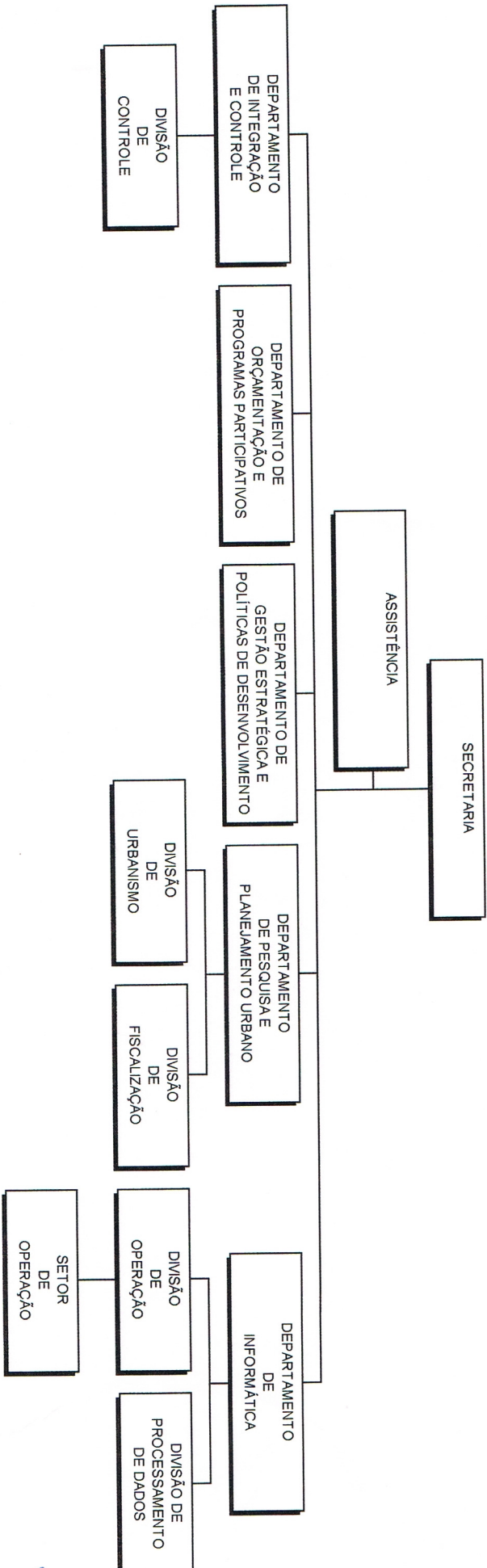



ESTADO DO RIO DE JANEIRO
CÂMARA MUNICIPAL DE BARRA DO PIRAI

SECRETARIA MUNICIPAL DE RECURSOS HUMANOS

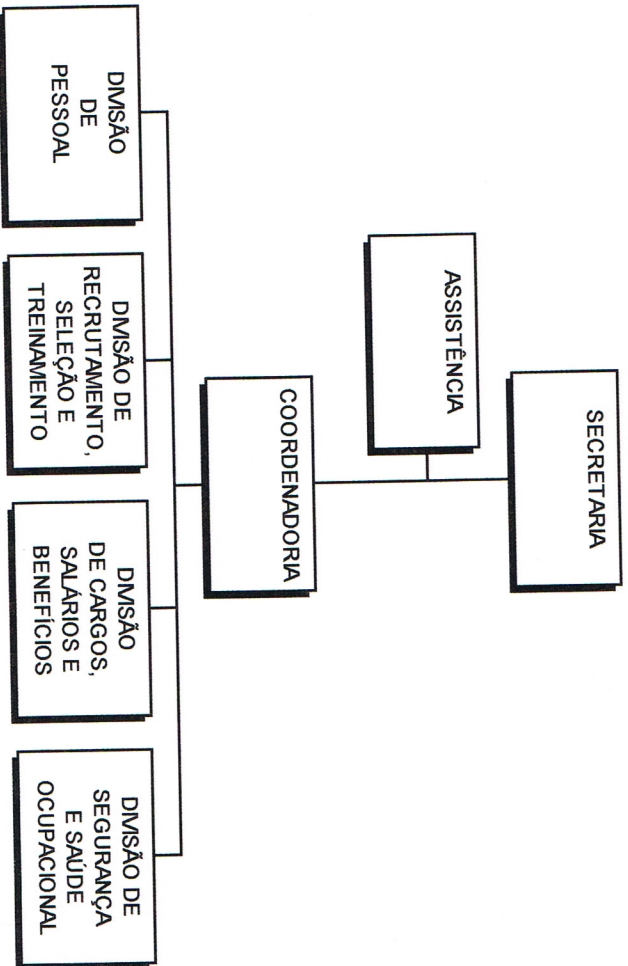

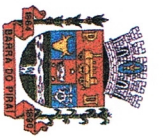

ESTADO DO RIO DE JANEIRO
CÂMARA MUNICIPAL DE BARRA DO PIRAI

SECRETARIA MUNICIPAL DE SAÚDE

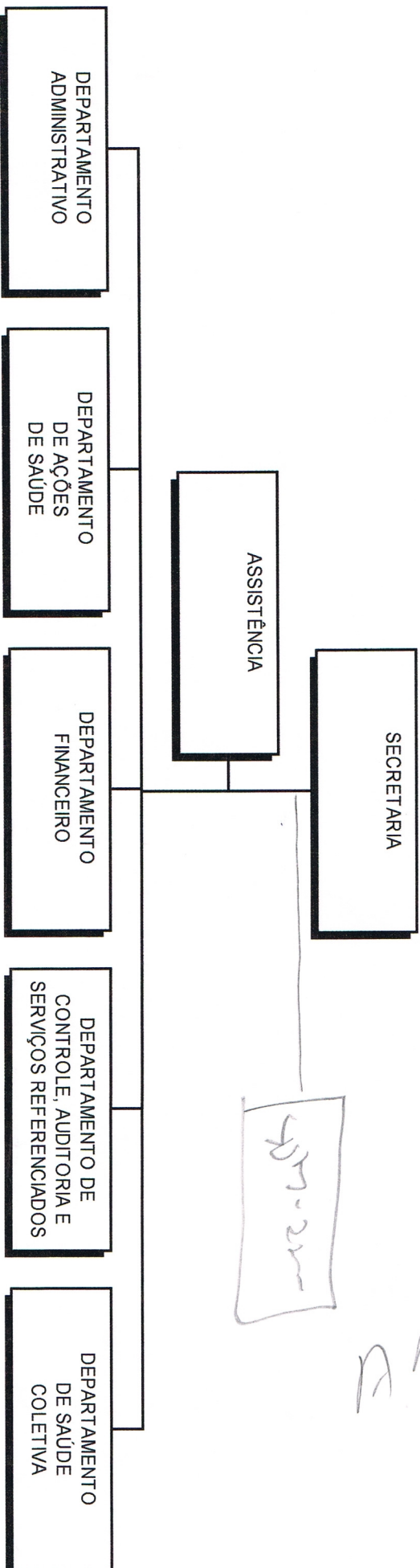

Handwritten signature: F. N. D. S. 1

Handwritten mark: A blue oval scribble.



ESTADO DO RIO DE JANEIRO
CÂMARA MUNICIPAL DE BARRA DO PIRAÍ

SECRETARIA MUNICIPAL DE SAÚDE (1)

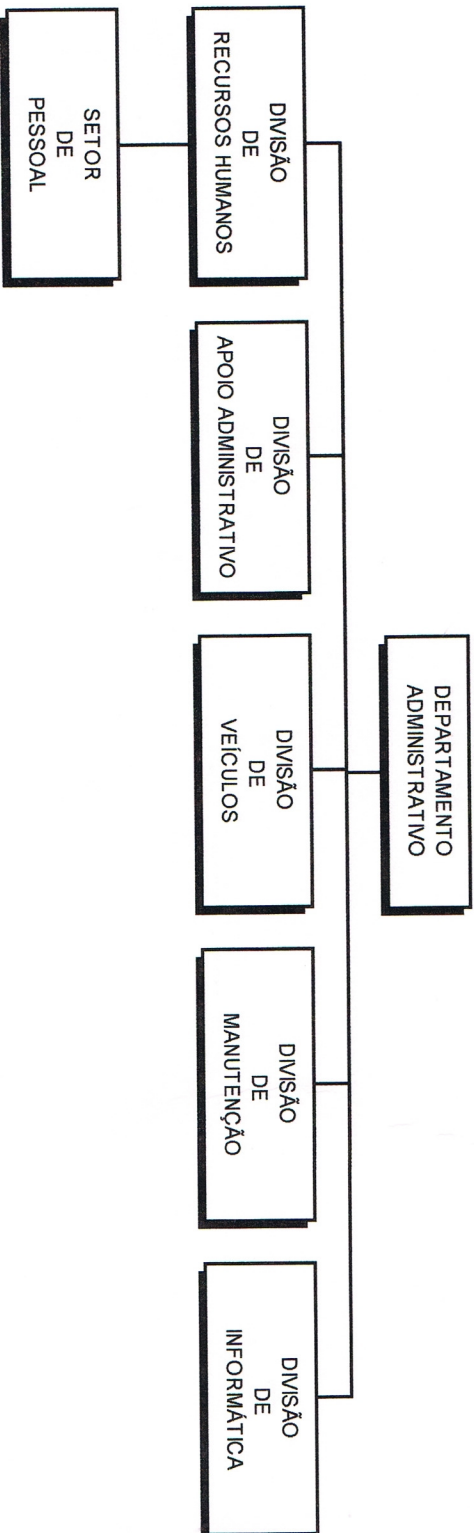

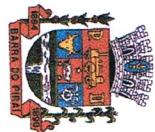

ESTADO DO RIO DE JANEIRO
CÂMARA MUNICIPAL DE BARRA DO PIRAI

SECRETARIA MUNICIPAL DE SAÚDE (3)

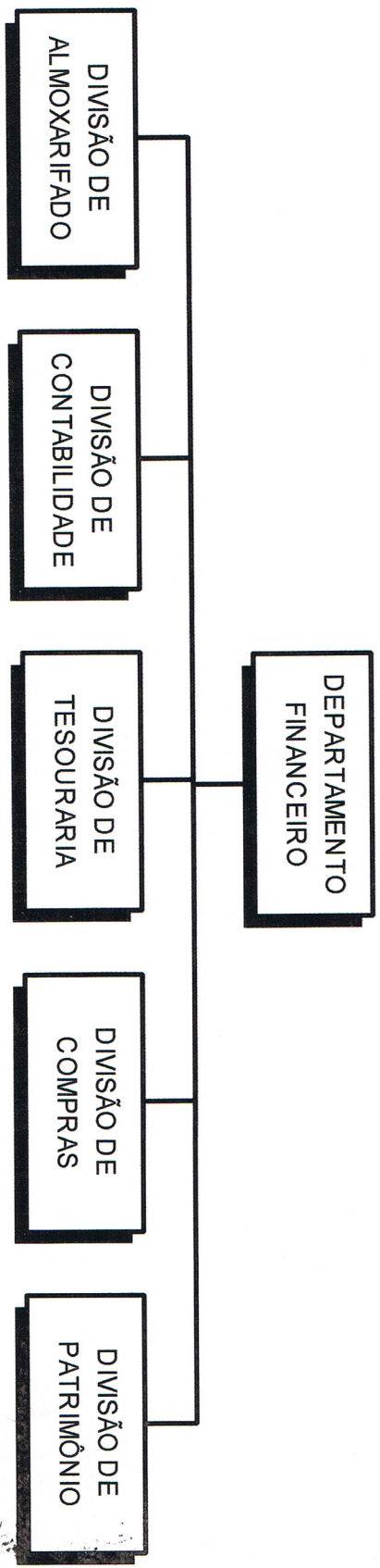

(Handwritten signature)



ESTADO DO RIO DE JANEIRO
CÂMARA MUNICIPAL DE BARRA DO PIRAÍ

SECRETARIA MUNICIPAL DE SAÚDE (4)

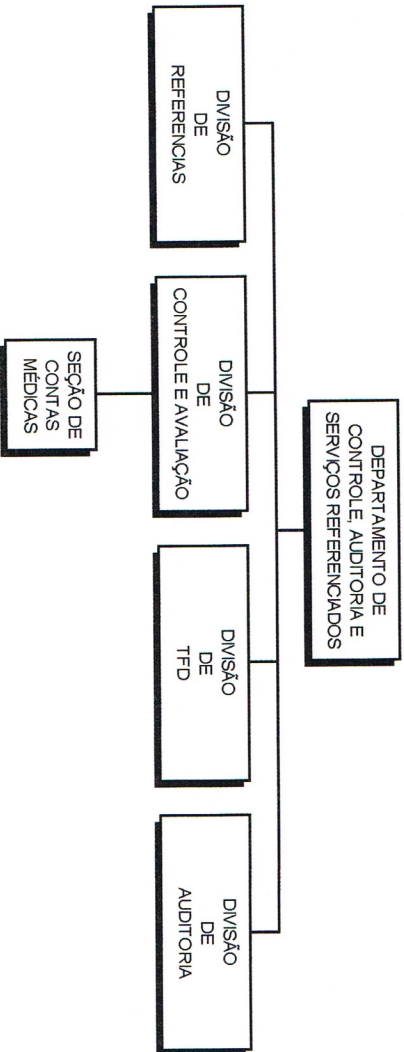



ESTADO DO RIO DE JANEIRO
CÂMARA MUNICIPAL DE BARRA DO PIRAI

SECRETARIA MUNICIPAL DE SAÚDE (5)

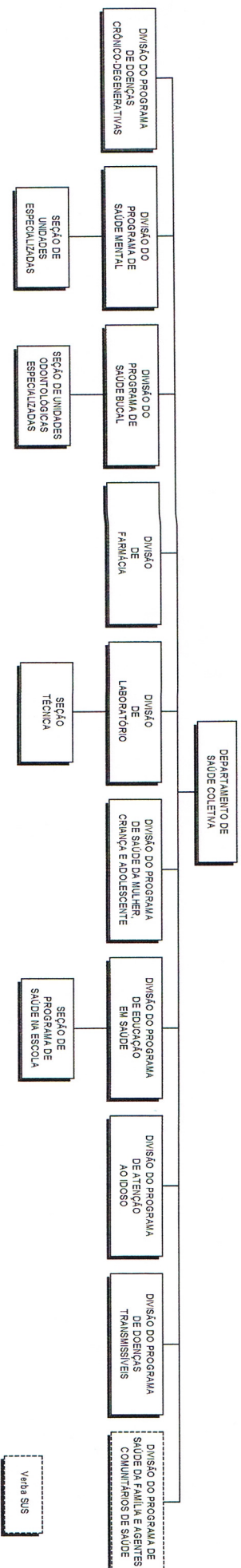



ESTADO DO RIO DE JANEIRO
CÂMARA MUNICIPAL DE BARRA DO PIRAI

SECRETARIA MUNICIPAL DE SERVIÇOS PÚBLICOS

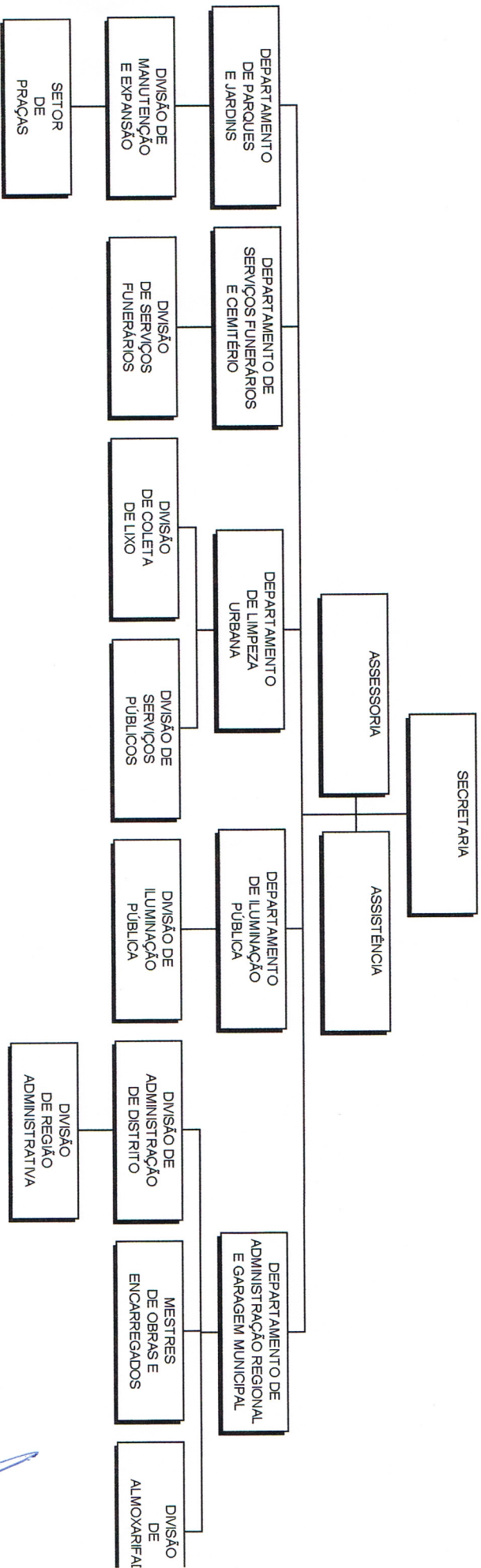

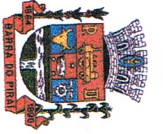

ESTADO DO RIO DE JANEIRO
CÂMARA MUNICIPAL DE BARRA DO PIRAI

SECRETARIA MUNICIPAL DE TRABALHO E DESENVOLVIMENTO ECONÔMICO

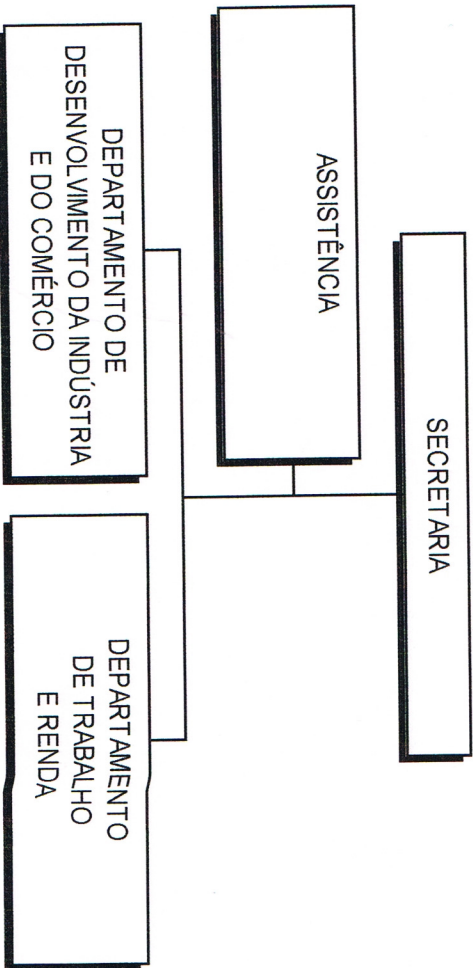

✓

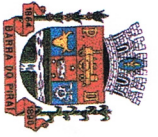

ESTADO DO RIO DE JANEIRO
CÂMARA MUNICIPAL DE BARRA DO PIRAI

SECRETARIA MUNICIPAL DE TURISMO, LAZER E CULTURA

